

# Tork Soap and Sanitizer Dispenser® with Arm Lever

Elevation  
Design

S4

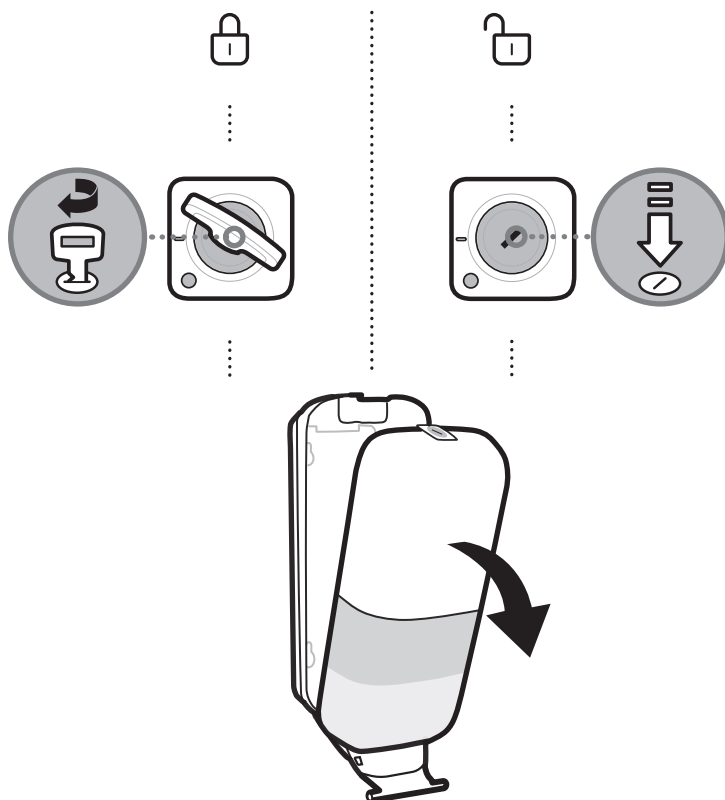

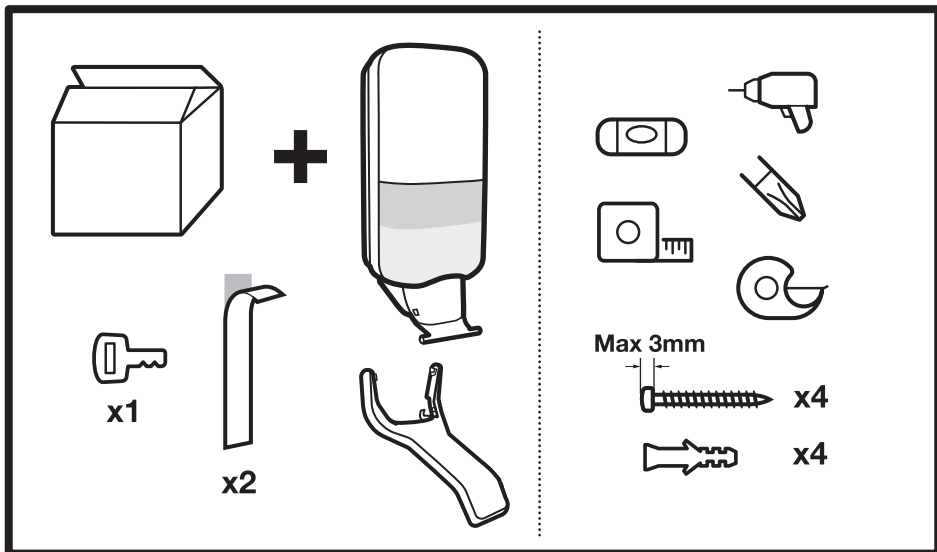

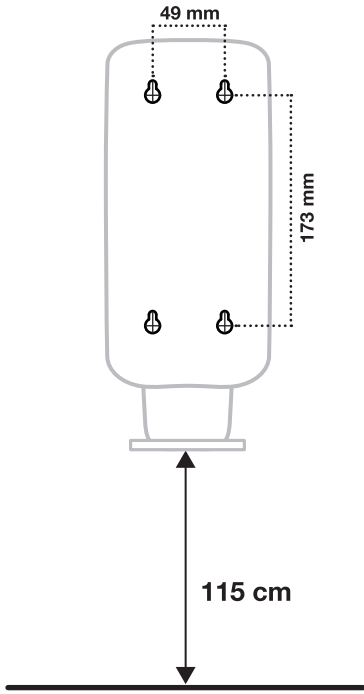

## Alt 1

1

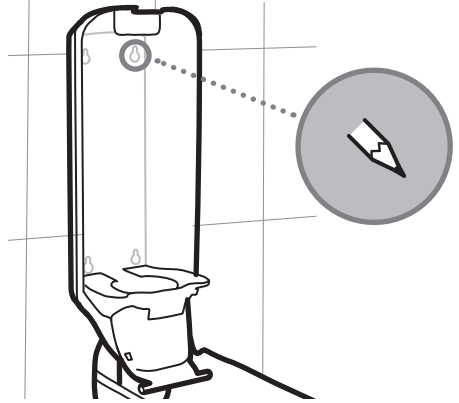

2

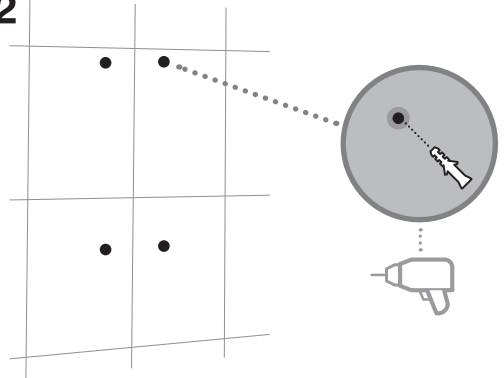

3

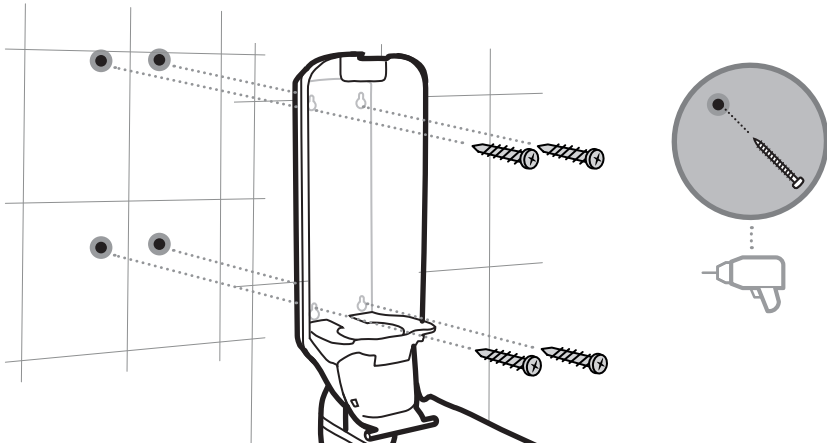

# Alt 2

1

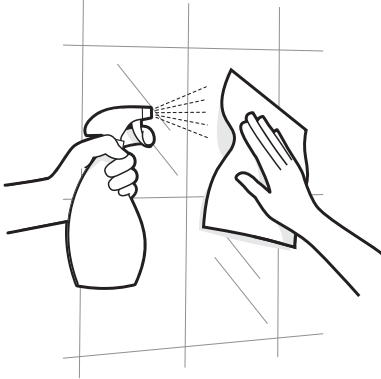

2

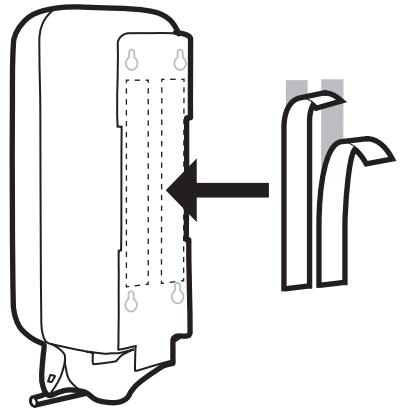

3

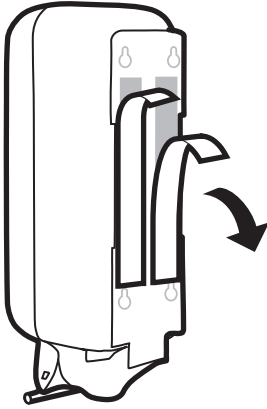

4

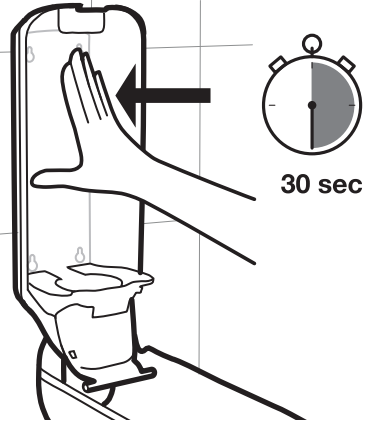

5



1

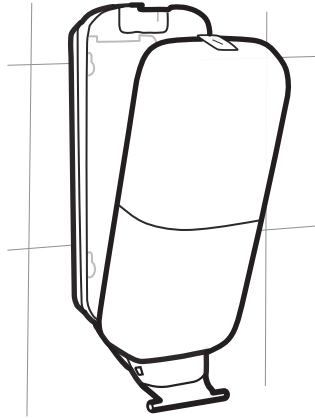

2

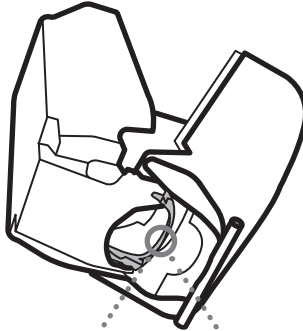

Alt 1



Alt 2

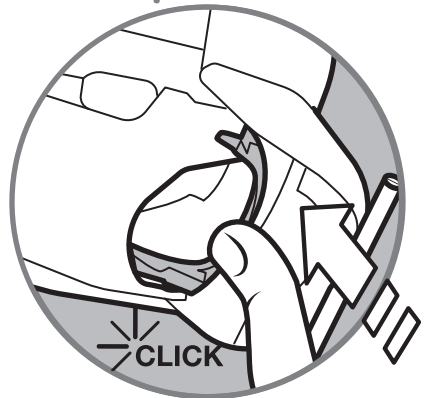
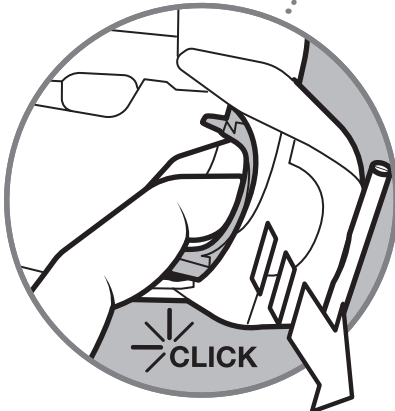

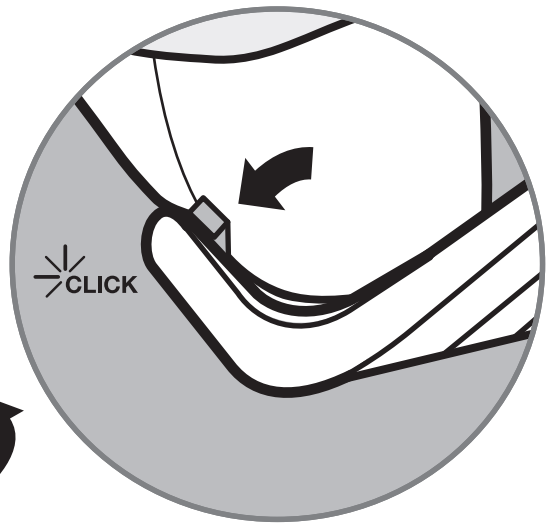
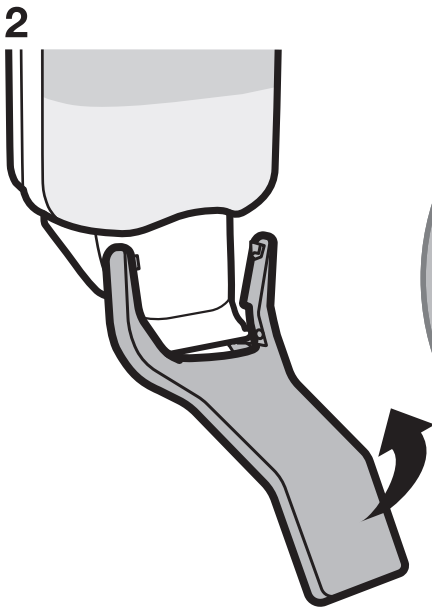
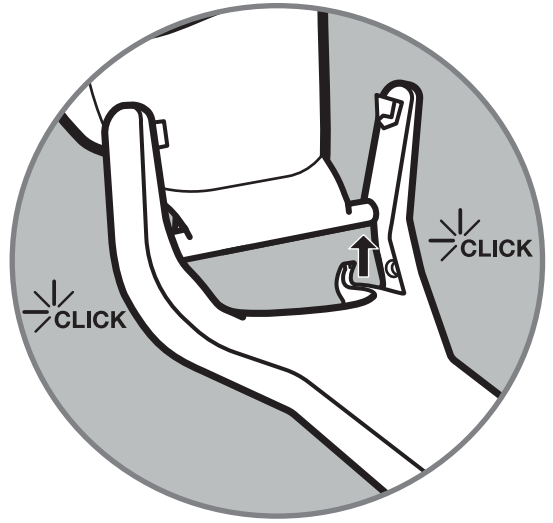
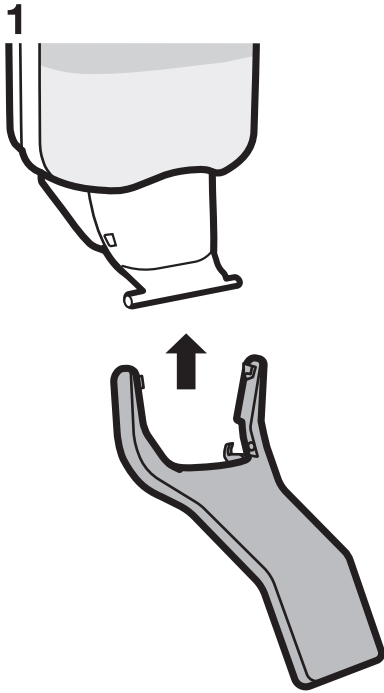

1

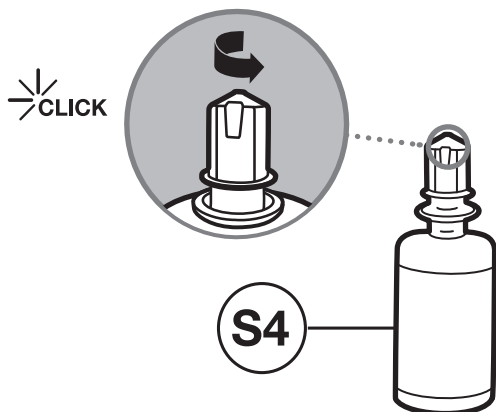

2

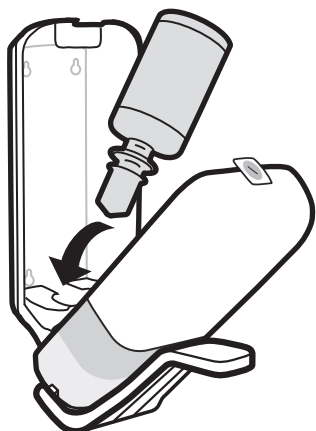

3

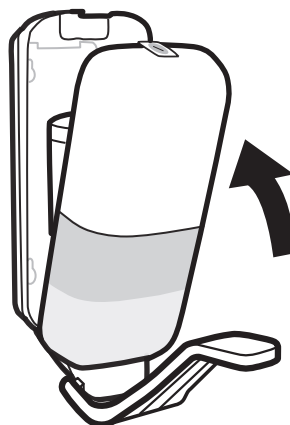

4

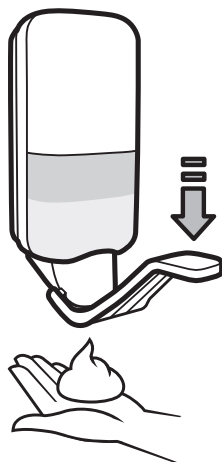

## Warning

- To avoid a potential shock hazard to dispenser users, do not install dispenser directly above an electrical outlet or within six inches from any edge of an electrical outlet.
- Do not place dispenser in a position where users must reach over an electrical outlet to access the dispenser.
- It is the installers responsibility to ensure installation of unit complies with all applicable codes, standards, and regulatory requirements including building codes and electrical codes.

## Disposal

- Damaged or malfunctioning product should be disposed of immediately to avoid potential of injury
- Products should be disposed of in accordance with applicable regulations

## Cleaning instructions

- Clean dispenser with mild detergent and soft cloth

European Community Design Registration RCD 015028064-0001



Manufactured by Essity Hygiene and Health AB

SE-40503 Göteborg, Sweden

Visiting address: Mölndals Bro 2, Mölndal

www.essity.com, www.torkglobal.com

Made in Hungary

Patents/Brevets/Patentes: [www.essity.com/patents](http://www.essity.com/patents)

Essity UK Limited

Southfields Road, Dunstable,

Bedfordshire, LU6 3EJ, UK